

# PARTS LIST

ULTRA HIGH SPEED  
**OVERLOCK/SAFETY**  
**STITCH MACHINE**



1

2

3

4

5

6

A

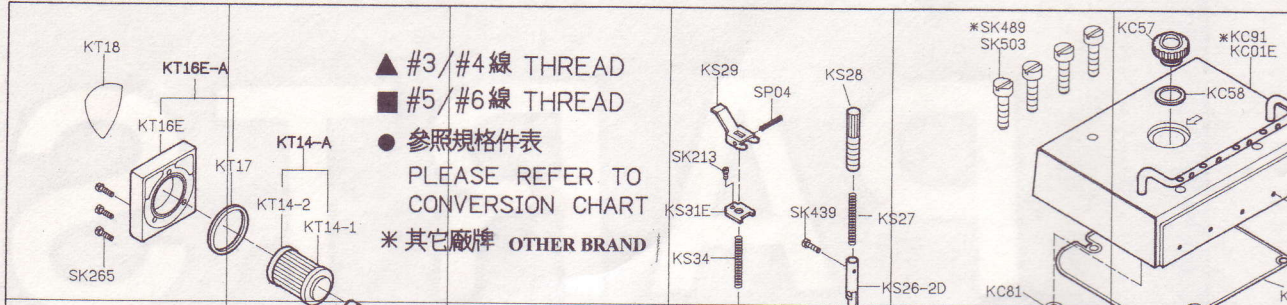

▲ #3/#4線 THREAD  
 ■ #5/#6線 THREAD  
 ● 参照規格件表  
 PLEASE REFER TO  
 CONVERSION CHART  
 \* 其它廠牌 OTHER BRAND

B

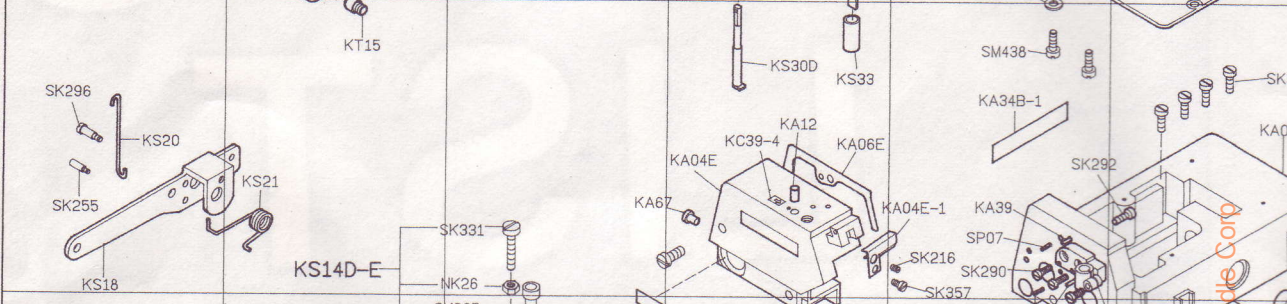

C

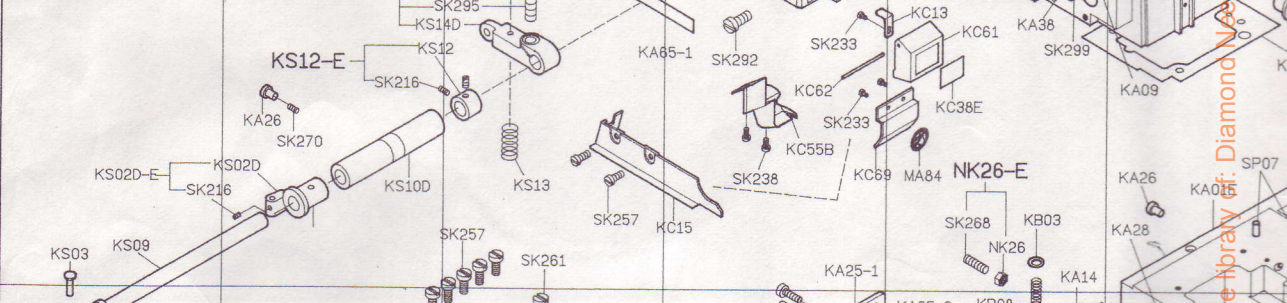

D

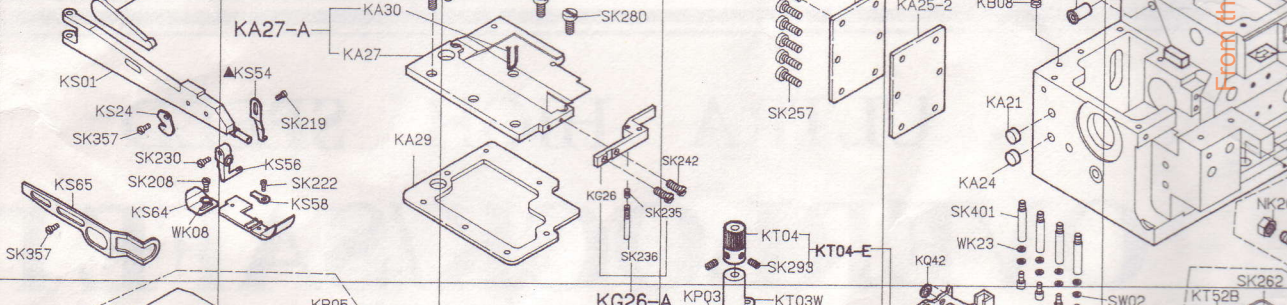

E

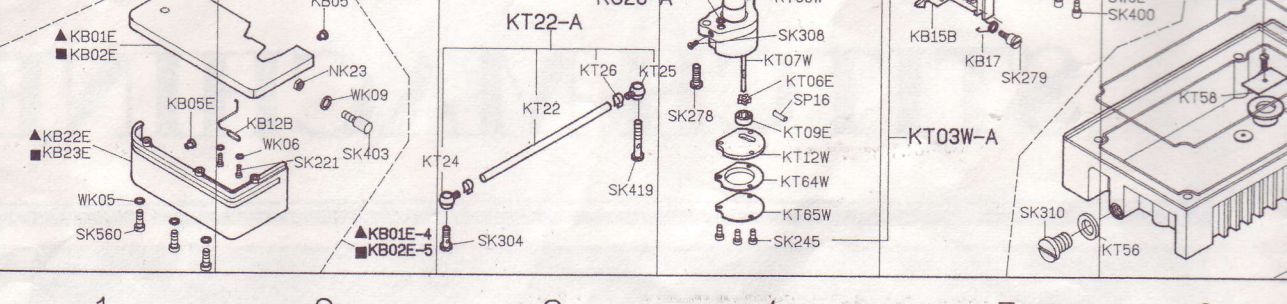

1

2

3

4

5

6

From the library of: Diamond Needle Corp











21 22 23 24 25 26

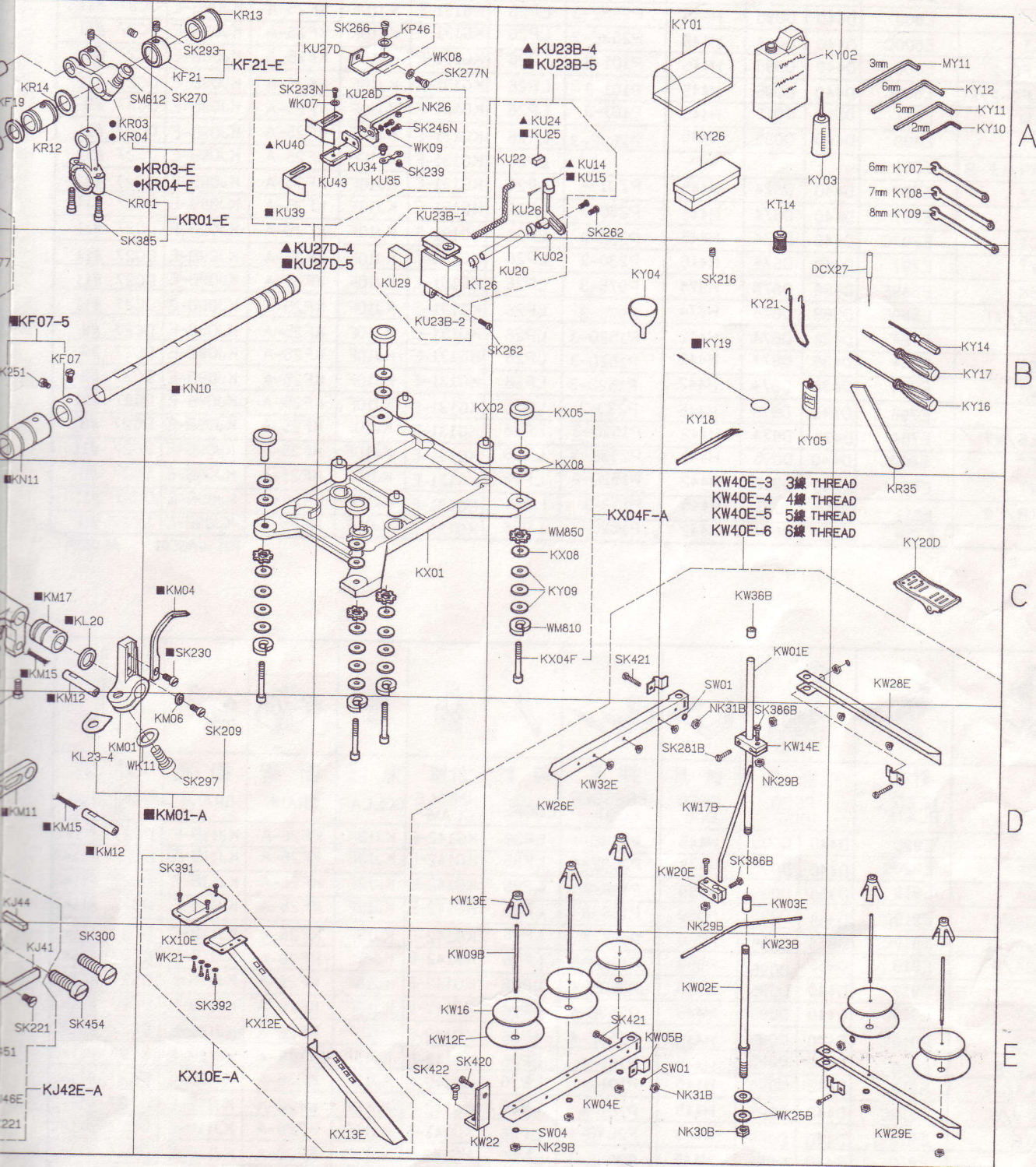





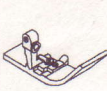

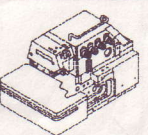
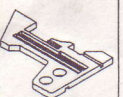
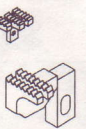

21 22 23 24 25 26



											
機 型 MODEL	針板 NEEDLE PLATE	送 具 FEED DOG		送 具 FEED DOG	押 具 PRESSER FOOT	勾 針 LOOPER	針留 NEEDLE CLAMP	束 子 COLLAR	衝 程 CRANK	衝 程 CRANK	針 號 NEEDLE
737E-504M1-15	E934	D438	D912	H442	P152D-A	LP26	KG131-E	KJ10F	KF25-A	KJ09B-E	DC27 #9
737E-504M2-04	E800	D440	D095	H445	P253E-3	LP26	KG131-E	KJ10F	KF25-A	KJ09B-E	DC27 #11
737E-504M2-04CT	E800C	D440	D095	H445	P253E-3	LP26	KG131-E	KJ10F	KF25-A	KJ09B-E	DC27 #11
737E-504M2-04LFC-2	E800	D440	D095	H445	P101-3	LP26	KG131-E	KJ10F	KF25-A	KJ09B-E	DC27 #11
737E-504M2-04LFC-2/EC	E800C	D440	D095	H445	P101-3	LP26	KG131-E	KJ10F	KF25-A	KJ09B-E	DC27 #11
737E-504M2-04TR	E011	D015	D011	H445	P101-3	LP26	KG131-E	KJ10F	KF25-A	KJ09B-E	DC27 #9
737E-504M2-04VT	E800	D440	D095	H445	P253E-3	LP26	KG131-E	KJ10F	KF25-A	KJ09B-E	DC27 #11
737E-504M2-04WR/LF-B	E001					LP26	KG131-E	KJ10F	KF25-A	KJ09B-E	DC27 #11
737E-504M3-05PZ	E797	D440	D674	H445	PZ01-A	LP26	KG131-E	KJ10F	KF25-A	KJ09B-E	DC27 #18
737E-504M3-05	E797	D440	D674	H445	P230-3	LP26	KG131-E	KJ10F	KF25-A	KJ09B-E	DC27 #11
737E-504M3-05CT	E797C	D440	D674	H445	P230-3	LP26	KG131-E	KJ10F	KF25-A	KJ09B-E	DC27 #11
737E-504M3-05VT	E797	D440	D674	H445	P230-3	LP26	KG131-E	KJ10F	KF25-A	KJ09B-E	DC27 #11
737E-504M5-04BK	E589E	D969	D675	H974	P975-3	LP26	KG131-E	KJ10F	KF25-A	KJ09B-E	DC27 #11
737E-504M5-04BK/VT	E589E	D969	D675	H974	P975-3	LP26	KG131-E	KJ10F	KF25-A	KJ09B-E	DC27 #11
737E-505F1-04	E784	D438	D674	H442	P152D-3	LP26	KG131-E	KJ10F	KF25-A	KJ09B-E	DC27 #9
737E-505F1-04ES	E784	D438	D674	H442	P152D-3	LP26	KG131-E	KJ10F	KF25-A	KJ09B-E	DC27 #9
737E-505F1-04VT	E784	D438	D674	H442	P152D-3	LP26	KG131-E	KJ10F	KF25-A	KJ09B-E	DC27 #9
737E-504M3-04	E796	D440	D674	H445	P230-3	LP26	KG131-E	KJ10F	KF25-A	KJ09B-E	DC27 #11
737E-505F1-04ES/VT	E784	D438	D674	H442	P152D-3	LP26	KG131-E	KJ10F	KF25-A	KJ09B-E	DC27 #9
737E-504M2-04EC	E800C	D440	D095	H445	P253E-3	LP26	KG131-E	KJ10F	KF25-A	KJ09B-E	DC27 #11
737E-504M1-15VT	E934	D438	D912	H442	P152D-A	LP26	KG131-E	KJ10F	KF25-A	KJ09B-E	DC27 #9
737E-504M2-04TR/EC	E011	D011	D015	H445	P103-3	LP26	KG131-E	KJ10F	KF25-A	KJ09B-E	DC27 #11
737E-504F1-04	E784	D438	D674	H442	P152D-3	LP26	KG131-E	KJ10F	KF25-A	KJ09B-E	DC27 #9







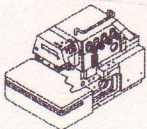
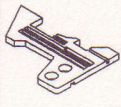
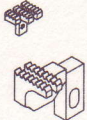

R11\GAGE01 86.08.28

											
機 型 MODEL	針板 NEEDLE PLATE	送 具 FEED DOG		送 具 FEED DOG	押 具 PRESSER FOOT	勾 針 LOOPER	針留 NEEDLE CLAMP	束 子 COLLAR	衝 程 CRANK	衝 程 CRANK	針 號 NEEDLE
747E-512M1-25	E920	D440	D095	H445	P253E-4	LP36	KG142-E	KJ13F	KF26-A	KJ11B-E	DC27 #11*2
747E-512M1-25CT	E920C	D440	D095	H445	P253E-4	LP36	KG142-E	KJ13F	KF26-A	KJ11B-E	DC27 #11*2
747E-514H4-24GA	E919	D958	D095	H959	P136-A	LP26	KG142-E	KJ13F	KF26-A	KJ11B-E	DC27 #11*2
747E-514H4-24GA/CT	E919C	D958	D095	H959	P136-A	LP26	KG142-E	KJ13F	KF26-A	KJ11B-E	DC27 #11*2
747E-514H4-24GA/EC	E919C	D958	D095	H959	P136-A	LP26	KG142-E	KJ13F	KF26-A	KJ11B-E	DC27 #11*2
747E-514H4-24GA/P	E919	D958	D095	H959	P136P-A	LP26	KG142-E	KJ13F	KF26-A	KJ11B-E	DC27 #11*2
747E-514M2-24	E919	D440	D095	H445	P253E-4	LP26	KG142-E	KJ13F	KF26-A	KJ11B-E	DC27 #11*2
747E-514M2-24CT	E919C	D440	D095	H445	P253E-4	LP26	KG142-E	KJ13F	KF26-A	KJ11B-E	DC27 #11*2
747E-514M2-24EC	E919C	D440	D095	H445	P253E-4	LP26	KG142-E	KJ13F	KF26-A	KJ11B-E	DC27 #11*2
747E-514M2-24LF-B	E919	D440	D095	H445	P101-4	LP26	KG142-E	KJ13F	KF26-A	KJ11B-E	DC27 #11*2
747E-514M2-24LFC-2	E919	D440	D095	H445	P101-4	LP26	KG142-E	KJ13F	KF26-A	KJ11B-E	DC27 #11*2
747E-514M2-24LFC-2/EC	E919C	D440	D095	H445	P101-4	LP26	KG142-E	KJ13F	KF26-A	KJ11B-E	DC27 #11*2
747E-514M2-24TG	E919	D440	D095	H445	P254G-4	LP26	KG142-E	KJ13F	KF26-A	KJ11B-E	DC27 #11*2
747E-512M1-25	E810	D440	D095	H445	P253E-4	LP36	KG142-E	KJ13F	KF26-A	KJ11B-E	DC27 #11*2
747E-512M1-25CT	E810C	D440	D095	H445	P253E-4	LP36	KG142-E	KJ13F	KF26-A	KJ11B-E	DC27 #11*2
747E-514H4-24GA	E809	D958	D095	H959	P136-A	LP26	KG142-E	KJ13F	KF26-A	KJ11B-E	DC27 #11*2
747E-514H4-24GA/CT	E809C	D958	D095	H959	P136-A	LP26	KG142-E	KJ13F	KF26-A	KJ11B-E	DC27 #11*2
747E-514H4-24GA/EC	E809C	D958	D095	H959	P136-A	LP26	KG142-E	KJ13F	KF26-A	KJ11B-E	DC27 #11*2
747E-514H4-24GA/P	E809	D958	D095	H959	P136P-A	LP36	KG142-E	KJ13F	KF26-A	KJ11B-E	DC27 #11*2
747E-514M2-24	E809	D440	D095	H445	P253E-4	LP36	KG142-E	KJ13F	KF26-A	KJ11B-E	DC27 #11*2
747E-514M2-24CT	E809C	D440	D095	H445	P253E-4	LP26	KG142-E	KJ13F	KF26-A	KJ11B-E	DC27 #11*2
747E-514M2-24EC	E809C	D440	D095	H445	P253E-4	LP26	KG142-E	KJ13F	KF26-A	KJ11B-E	DC27 #11*2
747E-514M2-24LF-B	E809	D440	D095	H445	P101-4	LP26	KG142-E	KJ13F	KF26-A	KJ11B-E	DC27 #11*2

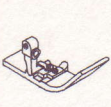





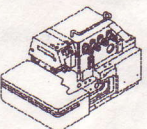
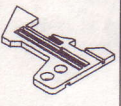
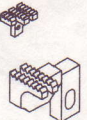

R11\GAGE02 86.08.28

From the library of: Diamond Needle Corp



											
機 型 MODEL	針板 NEEDLE PLATE	送 具 FEED DOG		送 具 FEED DOG	押 具 PRESSER FOOT	勾 針 LOOPER	針留 NEEDLE CLAMP	束 子 COLLAR	衝 程 CRANK	衝 程 CRANK	針 號 NEEDLE
747E-514M2-24LFC-2	E809	D440	D095	H445	P101-4	LP26	KG142-E	KJ13F	KF26-A	KJ11B-E	DC27 #11*2
747E-514M2-24LFC-2/EC	E809C	D440	D095	H445	P101-4	LP26	KG142-E	KJ13F	KF26-A	KJ11B-E	DC27 #11*2
747E-514M2-24TG	E809	D440	D095	H445	P254G-4	LP26	KG142-E	KJ13F	KF26-A	KJ11B-E	DC27 #11*2
747E-514M2-24TG/EC	E809C	D440	D095	H445	P254G-4	LP26	KG142-E	KJ13F	KF26-A	KJ11B-E	DC27 #11*2
747E-514M2-24VT	E809	D440	D095	H445	P253E-4	LP26	KG142-E	KJ13F	KF26-A	KJ11B-E	DC27 #11*2
747E-514M2-25TG	E810	D440	D095	H445	P254G-4	LP26	KG142-E	KJ13F	KF26-A	KJ11B-E	DC27 #11*2
747E-514M2-25	E810	D440	D095	H445	P253E-4	LP26	KG142-E	KJ13F	KF26-A	KJ11B-E	DC27 #11*2
747E-514M2-25CT	E810C	D440	D095	H445	P253E-4	LP26	KG142-E	KJ13F	KF26-A	KJ11B-E	DC27 #11*2
747E-512M1-34	E832	D440	D095	H447	P253E-A	LP36	KG143-E	KJ13F	KF26-A	KJ11B-E	DC27 #14*2
757E-401M1	E110	D105		H101	P767-A	LP26	KG153-E		KF26-A		DC27 #14*2
757E-401M2-50TA	E005	D005	D006	H005	P005E-A		TA155-E		KF26-A		DC27 #14*2
757E-401M2-50TA/EC	E005C	D005	D006	H005	P005E-A		TA155-E		KF26-A		DC27 #14*2
757E-516H2-56	E868	D490	D502	H501	P502-A	LP38	KG155-E	KJ13F	KF26-A	KJ11B-E	DC27 #18*2
757E-516H2-56CT	E868C	D490	D502	H501	P502-A	LP38	KG155-E	KJ13F	KF26-A	KJ11B-E	DC27 #18*2
757E-516H4-35GA	E982	D008	D502	H957	P508-A	LP26	KG153-E	KJ10F	KF25-A	KJ09B-E	DC27 #14*2
757E-516H4-35GA/EC	E982C	D008	D502	H957	P508-A	LP26	KG153-E	KJ10F	KF25-A	KJ09B-E	DC27 #14*2
757E-516H4-35GA/P	E982	D008	D502	H957	P508P-A	LP26	KG153-E	KJ10F	KF25-A	KJ09B-E	DC27 #14*2
757E-516H4-35GA/P/EC	E982C	D008	D502	H957	P508P-A	LP26	KG153-E	KJ10F	KF25-A	KJ09B-E	DC27 #14*2
757E-516H4-55GA	E986	D956	D502	H957	P509-A	LP26	KG155-E	KJ10F	KF25-A	KJ09B-E	DC27 #14*2
757E-516H4-55GA/EC	E986C	D956	D502	H957	P509-A	LP26	KG155-E	KJ10F	KF25-A	KJ09B-E	DC27 #14*2
757E-516H4-55GA/P	E986	D956	D502	H957	P509P-A	LP26	KG155-E	KJ10F	KF25-A	KJ09B-E	DC27 #14*2
757E-516H4-55GA/P/EC	E986C	D956	D502	H957	P509P-A	LP26	KG155-E	KJ10F	KF25-A	KJ09B-E	DC27 #14*2
757E-516L1-24	E834	D487	D060	H492	P500-A	LP26	KG152-E	KJ10F	KF25-A	KJ09B-E	DC27 #14*2

R11\GAGE03 86.08.28

											
機 型 MODEL	針板 NEEDLE PLATE	送 具 FEED DOG		送 具 FEED DOG	押 具 PRESSER FOOT	勾 針 LOOPER	針留 NEEDLE CLAMP	束 子 COLLAR	衝 程 CRANK	衝 程 CRANK	針 號 NEEDLE
757E-516L1-24CT	E834C	D487	D060	H492	P500-A	LP26	KG152-E	KJ10F	KF25-A	KJ09B-E	DC27 #14*2
757E-516L1-35	E839	D487	D060	H492	P504-A	LP26	KG153-E	KJ10F	KF25-A	KJ09B-E	DC27 #14*2
757E-516L1-35CT	E839C	D487	D060	H492	P504-A	LP26	KG153-E	KJ10F	KF25-A	KJ09B-E	DC27 #14*2
757E-516M2-35	E982	D489	D502	H497	P504-A	LP26	KG153-E	KJ13F	KF26-A	KJ11B-E	DC27 #14*2
757E-516M2-35CT	E982C	D489	D502	H497	P504-A	LP26	KG153-E	KJ13F	KF26-A	KJ11B-E	DC27 #14*2
757E-516M2-35PS	E982S	D489	D502	H497	P504S-A	LP26	KG153-E	KJ13F	KF26-A	KJ11B-E	DC27 #14*2
757E-516M2-35PS/EC	E982SC	D489	D502	H497	P504S-A	LP26	KG153-E	KJ13F	KF26-A	KJ11B-E	DC27 #14*2
757E-516M2-55	E986	D489	D502	H500	P502-A	LP26	KG155-E	KJ13F	KF26-A	KJ11B-E	DC27 #14*2
757E-516M2-55CT	E986C	D489	D502	H500	P502-A	LP26	KG155-E	KJ13F	KF26-A	KJ11B-E	DC27 #14*2
757E-516M2-55PS	E986S	D489	D502	H500	P502S-A	LP26	KG155-E	KJ13F	KF26-A	KJ11B-E	DC27 #14*2
757E-516M2-55PS/EC	E986SC	D489	D502	H500	P502S-A	LP26	KG155-E	KJ13F	KF26-A	KJ11B-E	DC27 #14*2
757E-516X2-56	E870	D490	D502	H501	P960-A	LP38	KG155-E	KJ13F	KF26-A	KJ11B-E	DC27 #18*2
757E-516X2-56CT	E870C	D490	D502	H501	P960-A	LP38	KG155-E	KJ13F	KF26-A	KJ11B-E	DC27 #18*2
757E-516X3-56	E870	D490	D502	H501	P960-A	LP38	KG155-E	KJ13F	KF26-A	KJ11B-E	DC27 #B64*2
757E-516X3-56CT	E870C	D490	D502	H501	P960-A	LP38	KG155-E	KJ13F	KF26-A	KJ11B-E	DC27 #B64*2
757E-516M2-55/EC	E986C	D489	D502	H500	P502-A	LP26	KG155-E	KJ13F	KF26-A	KJ11B-E	DC27 #14*2
757E-401M1/TW/CT	E110	D105		H101	P767-A	LP26	KG153-E	KJ10F	KF25-A	KJ09B-E	DC27 #18*2
767E-516M2-324	E989	D971	D502	H497	P233-A	LP26	KG333-E	KJ13F	KF26-A	KJ11B-E	DC27 #11*3
767E-516M2-324/CT	E989C	D971	D502	H497	P233-A	LP26	KG333-E	KJ13F	KF26-A	KJ11B-E	DC27 #11*3
767E-516M2-524	E988	D972	D502	H500	P255-A	LP26	KG355-E	KJ13F	KF26-A	KJ11B-E	DC27 #11*3
767E-516M2-524CT	E988C	D972	D502	H500	P255-A	LP26	KG355-E	KJ13F	KF26-A	KJ11B-E	DC27 #11*3

R11\GAGE04 86.08.28

From the library of: Diamond Tools



-KA-		8E KC29	13B KF34	21E KJ41	17E KN26	9B KQ31	-KT-	23E KW16
6C KA01E	8D KC36	12C KF35	20D KJ42E	17E KN27	9C KQ33	4E KT03W	25D KW17B	
4B KA04E	5C KC38E	12C KF35F-1	21D KJ44	18E KN29	9C KQ34	4D KT04	25D KW20E	
5B KA04E-1	4B KC39-4	13C KF37	20E KJ44	18E KN32	9C KQ35	4E KT06E	24E KW22	
4B KA06E	7D KC39-4		21E KJ46E	16E KN34	18A KQ35	4E KT07W	25E KW23B	
6B KA08E	7C KC39E-5	-KG-	19E KJ47	16D KN36-1	8B KQ37-1	4E KT09E	24D KW26E	
6C KA09	4C KC55B	7A KG02E	19E KJ49	15E KN36-2	8B KQ37-2	4E KT12W	26C KW28E	
6C KA10	6A KC57	8A KG03	7C KJ58	15E KN37	8B KQ37-3	25A KT14	26E KW29E	
4B KA12	6A KC58	9A KG04E	8D KJ61D	14E KN38	10C KQ40	2A KT14-1	24D KW32E	
5C KA14	5C KC61	9A KG05	8D KJ63	14E KN40	10C KQ41	2A KT14-2	25C KW36B	
5D KA21	4C KC62	8A KG06E	8D KJ68	14E KN42	10C KQ42	2B KT15		
7C KA22	4C KC69	8A KG07	18D KJ66D	14E KN43	5D KQ42	2A KT17	-KX-	
5D KA24	5A KC81	8A KG08	20E KJ70	14E KN44	10D KQ46D	1A KT16E	23C KX01	
4C KA25-1	6A KC91	7A KG09E	17C KJ71		11C KQ47	1A KT18	23B KX02	
5D KA25-2		7A KG10E	18C KJ71	-KP-	10D KQ48	3E KT22	24C KX04F	
6C KA26	-KD-	7B KG11F	17C KJ79	15D KP01	11D KQ49	3E KT24	24B KX05	
10B KA26	16B KD01	10A KG12		14D KP02	10D KQ50	3E KT25	24B KX08	
2C KA26	20A KD04E	10A KG13	-KL-	14D KP03		3E KT26	24C KX08	
2D KA27	19A KD05	9A KG14	20D KLO9B	4E KP03	-KR-	23B KT26	24C KX09	
6C KA28	19A KD09	9A KG15D	16D KL11	14C KP05D-1	21A KR01	8B KT38	22E KX10E	
2D KA29	19A KD10D	10A KG16	16D KL15	14C KP05D-2	21A KR03	8B KT39-1B	22E KX12E	
2D KA30	19A KD12D	14C KG17	15C KL16	14D KP06D	21A KR04	8B KT39E-1	23E KX13E	
7C KA33	18A KD13	14C KG18	15C KL17	13C KP08	20A KR07	8B KT39-2		
7D KA33	18B KD14	14C KG19	17D KL20	14D KP09D	20A KR09	8B KT41	-KY-	
5B KA34B-1	18A KD15	7A KG20	21C KL20	14D KP11	21A KR12	7B KT44D	25A KY03	
7D KA36E	18B KD16	14C KG21	17D KL21	13D KP13D	22A KR13	7E KT46E	25A KY04	
5C KA38	18B KD17	11D KG24D-1	16C KL22D	13D KP15	21A KR14	7E KT47E	25A KY05	
5B KA39	17B KD19	12D KG24D-2	17D KL23	13E KP18-1	20B KR19	7E KT49D	24B KY06	
7D KA40	17B KD20	3D KG26	19C KL23-1	12D KP18-1	20B KR20	7E KT51B	25B KY07	
7D KA42	14C KD21	10E KG31D	20C KL23-4	13E KP18-2	20B KR22	6E KT52B	26A KY08	
3C KA65-1	12D KD22	10E KG32D	21D KL23-4	13D KP21	20B KR23	6E KT56	26A KY09	
3B KA67	12E KD22	12D KG35	17D KL23-4	13D KP22	20B KR25	6E KT58	26A KY10	
	20A KD24	10E KG37	16C KL32-A	8C KP23	17A KR26	7E KT57	26A KY11	
-KB-	12E KD26D	10E KG39	17C KL35	12A KP25	17A KR27	7B KT61D	26B KY12	
1E KB01E	11E KD27D	11A KG42	8C KL38	13A KP28	17A KR29	4E KT64W	26A KY13	
1E KB02E	12E KD28D	11A KG54	7E KL46	11A KP30B	17A KR32	4E KT65W	26A KY14	
5C KB03	12D KD28D	17C KG59	15C KL57	12A KP31	17B KR33		26A KY15	
7D KB05	12E KD33	7B KG60F		12A KP32	17A KR35	-KU-	26A KY16	
11D KB05		7A KG68	-KM-	14A KP32	17A KR35	24B KU02	26B KY17	
2E KB05		9A KG68	21D KM01	12A KP34	26C KR35	24A KU14	26B KY18	
1E KB05E	-KF-	12D KG471	22C KM04	12A KP35D	18A KR36	24A KU15	26B KY19	
7D KB06E-1	14A KF01	12D KG472	22D KM06	11B KP39		10E KU18	26B KY20	
5D KB08	12B KF02		20C KM08	12B KP43	-KS-	24B KU20	25B KY18	
2E KB12B	14A KF05		21D KM11	11B KP46	1D KS01	24A KU22	25B KY19	
5E KB15B	15A KF07	-KJ-	21D KM12	23A KP46	2C KS02D	24A KU24	26C KY20D	
5E KB17	21B KF07	17C KJ01B	21C KM12	12D KP59	1C KS03	24A KU25	25B KY21	
1E KB22E	13B KF09	18C KJ01B	21C KM15	11B KP60	1C KS09	24A KU26	25A KY26	
1E KB23E	12B KF10F	17C KJ06B	21D KM15	12B KP62	2C KS10D	23A KU23B-1		
10D KB29	13B KF11	18B KJ06B	21C KM17	12B KP63	2C KS12	23B KU23B-2	-MA-	
8D KB31D-1	13B KF12	18C KJ10F	20C KM18	12B KP64	3C KS13	23A KU27D	5C MA84	
7D KB31D-2	14B KF14	18C KJ13F	20C KM26	11B KP65B	2C KS14D	23A KU28D		
	20D KF14-3	17C KJ15	19C KM27D		1B KS18	23B KU29	-MY-	
	14B KF16	8C KJ16	19B KM28	-KQ-	1B KS20	23A KU34	26A MY11	
-KC-	14B KF17	16C KJ16	19B KM29D	10C KQ05	2B KS21	23A KU35		
6A KC01E	15A KF18	17C KJ19F		10B KQ07	1D KS24	23A KU35		
6A KC03	21A KF19	18C KJ20	-KN-	9C KQ10	4A KS26-2D	22A KU39		
6A KC05E	14B KF19	19D KJ21	13E KN01	14C KQ11	4A KS27	22A KU40		
7C KC09E	16A KF20	8D KJ21	13E KN02	14C KQ12	4A KS28	23A KU43		
5C KC13	16A KF21	18D KJ22	13E KN03	14C KQ13	4A KS29		-KW-	
4C KC15	10A KF21	20E KJ26E	18B KN05	9C KQ14	4B KS30D	25C KW01E		
7B KC17	22A KF21	20E KJ27	19C KN08	10B KQ15	4A KS31E	25E KW02E		
8E KC18	15A KF23	20D KJ28	22B KN10	9C KQ17	4B KS33	25D KW03E		
9D KC20	15A KF25	20D KJ29	21C KN11	11B KQ19	4A KS34	24E KW04E		
9E KC21E	15A KF26	19D KJ30D	18C KN12	10B KQ21	2D KS54	25E KW05E		
8E KC22B	16B KF28	20D KJ31D	18C KN13	8C KQ24	2D KS56	23E KW09B		
8E KC23B	16A KF30	19D KJ34	11E KN18	10A KQ25	2D KS58	23E KW12E		
8E KC24B	14C KF31	19E KJ37	17E KN20	9B KQ28	1D KS64	23D KW13E		
8E KC25B	13B KF32	19E KJ39F	17E KN22	9B KQ30	1D KS65	25D KW14		
8E KC28	13C KF33	19E KJ40F	17E KN24					

From the National Library of Medicine